



ottomotores

VOLVO TWD1643

Energía que Mueve al Mundo

Definiciones

Potencia Prime

Clasificación corresponde a la norma ISO de energía para funcionamiento continuo

Es aplicable para el suministro de energía eléctrica a carga variable durante un número ilimitado de horas en lugar de red eléctrica comercial una sobrecarga de 10% está disponible para esta calificación.

Potencia Stand by

Se aplica para proporcionar energía eléctrica a una carga variable, en las zonas con redes eléctricas instaladas, para restablecer el servicio en caso de fallo en la red normal

No tienen capacidad de sobrecarga para esta calificación:

1hp = 1 kW-1.36

Nota: el rendimiento del motor corresponde a normas ISO3046, BS5514 y DIN 6217.

Potencia garantizada en 0 a 2% nominal en condiciones ambientales, los valores se basan en la norma ISO8528

Modelo	Voltaje	Prime kVA	Prime kWe
VNY600	220-440V	687 ⁽²⁾	550
		Stand-by kVA	Stand-by kWe
		757 ⁽³⁾	605

⁽²⁾ Prime kVA (125/40 rise)

⁽³⁾ Prime kVA (125/40 rise)

0.8 Factor de potencia

Datos Técnicos	VNY600
Modelo:	TWD1643GE
Número de cilindros:	6 en línea
Diametro: mm (in)	144 (5.67)
Carrera: mm (in)	165 (6.50)
Desplazamiento: lts (in ³)	16.12 (984)
Radio de compresion:	16.5:1
Desempeño	
Ventilador: kW(hp)	644 (876)
Sistema de Lubricación	
Consumo de aceite: lt/h(gal/h)	0.11 (0.039)
Aceite Incluye filtros: (lts)	48
Sistema de Combustible	
100% Carga : g/kWh (lb/hph)	204 (0.331)
Sistema de admision y escape.	
Consumo aire: m ³ /min (cfm)	55 (1937)
Max.restriccion: kP (ln wc)	5 (20.1)
Calor rechazado en escape: kW (BTU/min)	530 (30141)
Temperatura de escape: C° (°F)	461 (862)
Max.contrapresion: kP (ln wc)	10 (40.2)
Flujo en sistema de escape: m ³ /min (cfm)	130.1(4593)
Modelo:	
Modelo de generador:	HCI534E
Aislamiento :	Clase H
Control :	Auto exitado
Regulador de Voltaje:	SX460

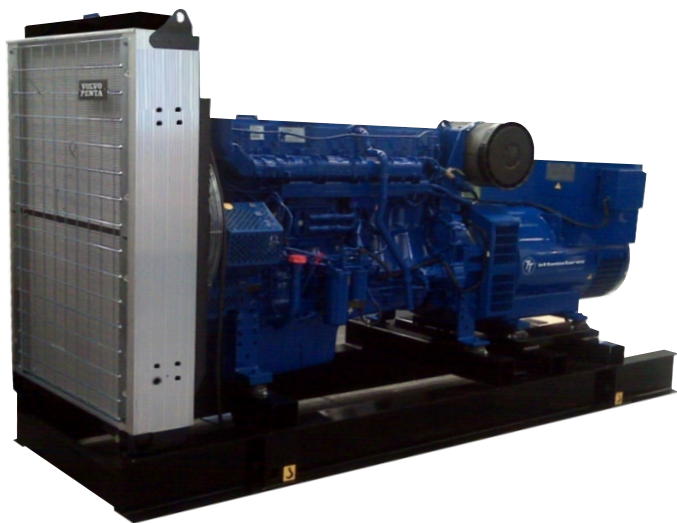

Nota: Imagen de carácter ilustrativa ya que los equipos en foto pudieran incluir accesorios opcionales



Como leer nuestro codigo: Ejem:VNY600

V=Motor Volvo Penta
N=Generador Newage Stamford
Y=60Hz-1800 RPM
600= Potencia del Equipo.



LAPEM

Ottomotores, S.A de C.V.

Calz. San Lorenzo No.1150
Col. Cerro de la estrella, C.P. 09860
Delg. Iztapalapa México, D.F.
Tels:52-55-5624-5600

Fax: 52-55-5426-5521 / 52-55-5426-5581
email: ventas@ottomotores.com.mx

Web site: www.ottomotores.com.mx

Dimensiones



Tabla de Dimensiones

Motor	Equipo con Base Estructural			Equipo con Base Tanque			Equipo con Caseta Acústica*		
	A	B	C	x	y	z	D	E	F
C.pack	345,00	140,00	199,50	381,00	175,00	224,00	500,00	175,00	255,00
	Peso: 3611,00 kgs			Peso: 5663,00 kgs			Peso: 6641,00 kgs		

[*] Equipo opcional

Información Técnica

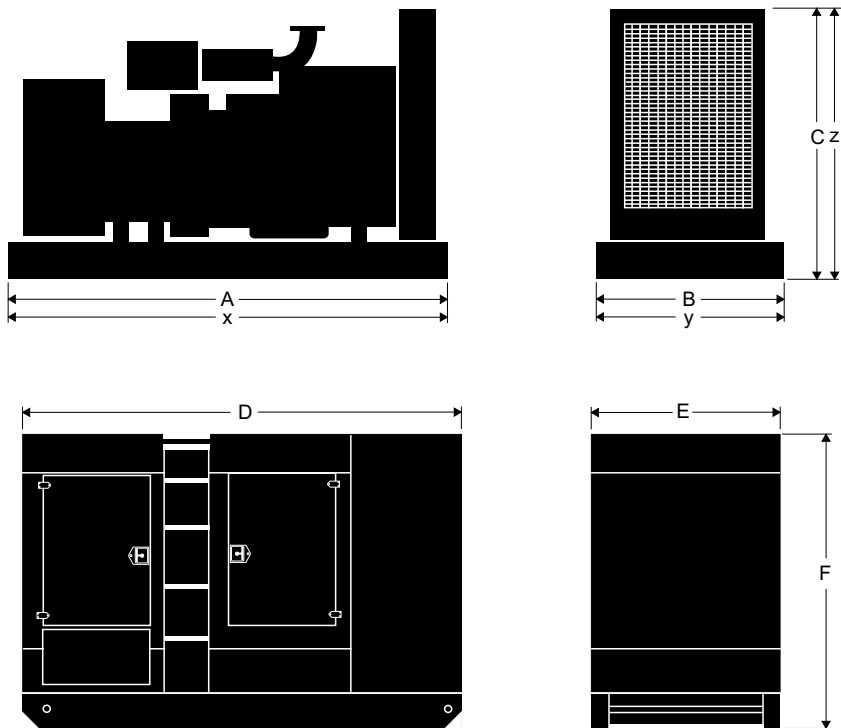
Nota: las condiciones de referencia estándar son de 25 °C (77 ° F) temperatura de entrada de aire. Todos los datos de desempeño de motores son basados en la potencia mencionada arriba.

Datos de consumo de combustible a plena carga con combustible diesel tienen una gravedad específica de 0,85.

Comercializado por:

Módulos de Control



Ottomotores tiene una posición única en la fabricación de grupos electrógenos utilizando en ellos módulos de control que cumplen con todos los niveles de requerimiento del mercado nacional y de exportación.



Las diferentes soluciones de controles que se tienen para nuestra gama de plantas generadoras, permite una operación simple en modo manual y automático, así mismo permiten desarrollar proyectos de sincronía entre plantas generadoras o con la red de energía eléctrica.



La familia de módulos de control en transición abierta (DALE 3200) permite tener control en forma automática de la unidad de transferencia, así como el monitoreo del grupo generador.



Nuestro módulos de control cuentan con puerto de comunicación RS485 para la comunicación remota con el grupo generador.



Los módulos pueden ser monitoreados através de un excelente software para observar parámetros del equipo de manera fácil y rápida.



La familia de módulos de control para la sincronía (6100, 6050 y 6300), incorporan un amplio sistema de monitoreos además de conexión a Internet (LAN) o mensaje SMS vía celular, o usando los puertos de comunicación RS485 a través de ModBus



ottomotores

Energía que Mueve al Mundo

Calz. San Lorenzo No.1150
Col. Cerro de la Estrella, C.P.09860
Delegación Iztapalapa México D.F.
Tels: 52-55-5624-5600
Fax.52-55-5426-55-21 / 52-55-54265581

E-mail ventas1@ottomotores.com.mx
ventas2@ottomotores.com.mx

Web site. www.ottomotores.com.mx

HCI 534E/544E - Technical Data Sheet

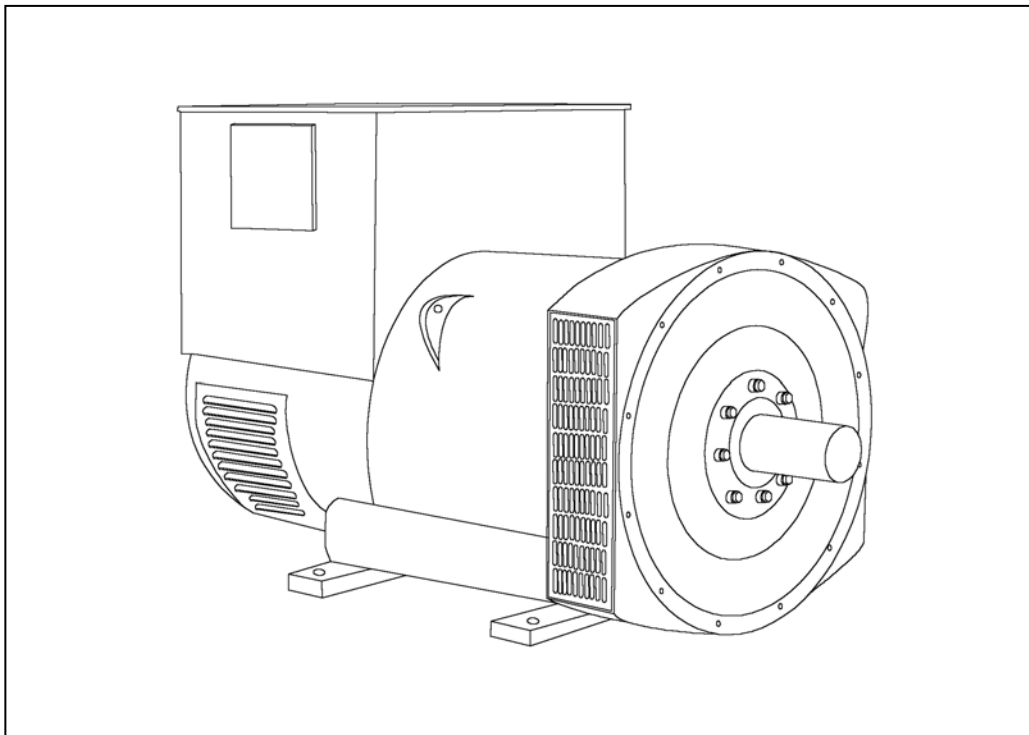

HCI534E/544E

SPECIFICATIONS & OPTIONS



STANDARDS

Newage Stamford industrial generators meet the requirements of BS EN 60034 and the relevant section of other international standards such as BS5000, VDE 0530, NEMA MG1-32, IEC34, CSA C22.2-100, AS1359. Other standards and certifications can be considered on request.

VOLTAGE REGULATORS

SX440 AVR - STANDARD

With this self-excited system the main stator provides power via the Automatic Voltage Regulator (AVR) to the exciter stator. The high efficiency semi-conductors of the AVR ensure positive build-up from initial low levels of residual voltage.

The exciter rotor output is fed to the main rotor through a three-phase full-wave bridge rectifier. The rectifier is protected by a surge suppressor against surges caused, for example, by short circuit or out-of-phase paralleling.

The SX440 will support a range of electronic accessories, including a 'droop' Current Transformer (CT) to permit parallel operation with other ac generators.

If 3-phase sensing is required with the self-excited system, the SX421 AVR must be used.

SX421 AVR

This AVR also operates in a self-excited system. It combines all the features of the SX440 with, additionally, three-phase rms sensing for improved regulation and performance. Over voltage protection is provided via a separate circuit breaker. An engine relief load acceptance feature is built in as standard.

MX341 AVR

This sophisticated AVR is incorporated into the Stamford Permanent Magnet Generator (PMG) control system.

The PMG provides power via the AVR to the main exciter, giving a source of constant excitation power independent of generator output. The main exciter output is then fed to the main rotor, through a full wave bridge, protected by a surge suppressor. The AVR has in-built protection against sustained over-excitation, caused by internal or external faults. This de-excites the machine after a minimum of 5 seconds.

An engine relief load acceptance feature can enable full load to be applied to the generator in a single step.

If three-phase sensing is required with the PMG system the MX321 AVR must be used.

We recommend three-phase sensing for applications with greatly unbalanced or highly non-linear loads.

MX321 AVR

The most sophisticated of all our AVRs combines all the features of the MX341 with, additionally, three-phase rms sensing, for improved regulation and performance.

Over voltage protection is built-in and short circuit current level adjustments is an optional facility.

WINDINGS & ELECTRICAL PERFORMANCE

All generator stators are wound to 2/3 pitch. This eliminates triplen (3rd, 9th, 15th ...) harmonics on the voltage waveform and is found to be the optimum design for trouble-free supply of non-linear loads. The 2/3 pitch design avoids excessive neutral currents sometimes seen with higher winding pitches, when in parallel with the mains. A fully connected damper winding reduces oscillations during paralleling. This winding, with the 2/3 pitch and carefully selected pole and tooth designs, ensures very low waveform distortion.

TERMINALS & TERMINAL BOX

Standard generators are 3-phase reconnectable with 12 ends brought out to the terminals, which are mounted on a cover at the non-drive end of the generator. A sheet steel terminal box contains the AVR and provides ample space for the customers' wiring and gland arrangements. It has removable panels for easy access.

SHAFT & KEYS

All generator rotors are dynamically balanced to better than BS6861:Part 1 Grade 2.5 for minimum vibration in operation. Two bearing generators are balanced with a half key.

INSULATION/IMPREGNATION

The insulation system is class 'H'.

All wound components are impregnated with materials and processes designed specifically to provide the high build required for static windings and the high mechanical strength required for rotating components.

QUALITY ASSURANCE

Generators are manufactured using production procedures having a quality assurance level to BS EN ISO 9001.

The stated voltage regulation may not be maintained in the presence of certain radio transmitted signals. Any change in performance will fall within the limits of Criteria 'B' of EN 61000-6-2:2001. At no time will the steady-state voltage regulation exceed 2%.

NB Continuous development of our products entitles us to change specification details without notice, therefore they must not be regarded as binding.

Front cover drawing typical of product range.

HCI534E/544E

WINDING 311

CONTROL SYSTEM	SEPARATELY EXCITED BY P.M.G.							
A.V.R.	MX321	MX341						
VOLTAGE REGULATION	± 0.5 %	± 1.0 %	With 4% ENGINE GOVERNING					
SUSTAINED SHORT CIRCUIT	REFER TO SHORT CIRCUIT DECREMENT CURVES (page 7)							
CONTROL SYSTEM	SELF EXCITED							
A.V.R.	SX440	SX421						
VOLTAGE REGULATION	± 1.0 %	± 0.5 %	With 4% ENGINE GOVERNING					
SUSTAINED SHORT CIRCUIT	SERIES 4 CONTROL DOES NOT SUSTAIN A SHORT CIRCUIT CURRENT							
INSULATION SYSTEM	CLASS H							
PROTECTION	IP23							
RATED POWER FACTOR	0.8							
STATOR WINDING	DOUBLE LAYER LAP							
WINDING PITCH	TWO THIRDS							
WINDING LEADS	12							
STATOR WDG. RESISTANCE	0.0043 Ohms PER PHASE AT 22°C SERIES STAR CONNECTED							
ROTOR WDG. RESISTANCE	1.96 Ohms at 22°C							
R.F.I. SUPPRESSION	BS EN 61000-6-2 & BS EN 61000-6-4,VDE 0875G, VDE 0875N. refer to factory for others							
WAVEFORM DISTORTION	NO LOAD < 1.5% NON-DISTORTING BALANCED LINEAR LOAD < 5.0%							
MAXIMUM OVERSPEED	2250 Rev/Min							
BEARING DRIVE END	BALL. 6220 (ISO)							
BEARING NON-DRIVE END	BALL. 6314 (ISO)							
	1 BEARING				2 BEARING			
WEIGHT COMP. GENERATOR	1543 kg				1535 kg			
WEIGHT WOUND STATOR	722 kg				722 kg			
WEIGHT WOUND ROTOR	617 kg				588 kg			
WR ² INERTIA	8.9828 kgm ²				8.7049 kgm ²			
SHIPPING WEIGHTS in a crate	1635 kg				1625 kg			
PACKING CRATE SIZE	166 x 87 x 124(cm)				166 x 87 x 124(cm)			
	50 Hz				60 Hz			
TELEPHONE INTERFERENCE	THF<2%				TIF<50			
COOLING AIR	1.035 m ³ /sec 2202 cfm				1.312 m ³ /sec 2780 cfm			
VOLTAGE SERIES STAR	380/220	400/231	415/240	440/254	416/240	440/254	460/266	480/277
VOLTAGE PARALLEL STAR	190/110	200/115	208/120	220/127	208/120	220/127	230/133	240/138
VOLTAGE SERIES DELTA	220/110	230/115	240/120	254/127	240/120	254/127	266/133	277/138
KVA BASE RATING FOR REACTANCE VALUES	600	600	600	600	681	713	731	750
X _d DIR. AXIS SYNCHRONOUS	3.14	2.83	2.63	2.34	3.53	3.30	3.10	2.92
X' _d DIR. AXIS TRANSIENT	0.17	0.15	0.14	0.12	0.17	0.16	0.15	0.14
X'' _d DIR. AXIS SUBTRANSIENT	0.12	0.11	0.10	0.09	0.12	0.11	0.11	0.10
X _q QUAD. AXIS REACTANCE	2.45	2.21	2.05	1.82	2.82	2.64	2.48	2.33
X'' _q QUAD. AXIS SUBTRANSIENT	0.26	0.24	0.22	0.20	0.34	0.32	0.30	0.28
X _L LEAKAGE REACTANCE	0.06	0.05	0.05	0.04	0.06	0.06	0.05	0.05
X ₂ NEGATIVE SEQUENCE	0.18	0.16	0.15	0.13	0.23	0.22	0.20	0.19
X ₀ ZERO SEQUENCE	0.08	0.08	0.07	0.06	0.10	0.09	0.09	0.08
REACTANCES ARE SATURATED VALUES ARE PER UNIT AT RATING AND VOLTAGE INDICATED								
T' _d TRANSIENT TIME CONST.	0.08s							
T'' _d SUB-TRANSTIME CONST.	0.012s							
T' _{do} O.C. FIELD TIME CONST.	2.5s							
T _a ARMATURE TIME CONST.	0.019s							
SHORT CIRCUIT RATIO	1/X _d							

**50
Hz**

HCI534E/544E
Winding 311



THREE PHASE EFFICIENCY CURVES

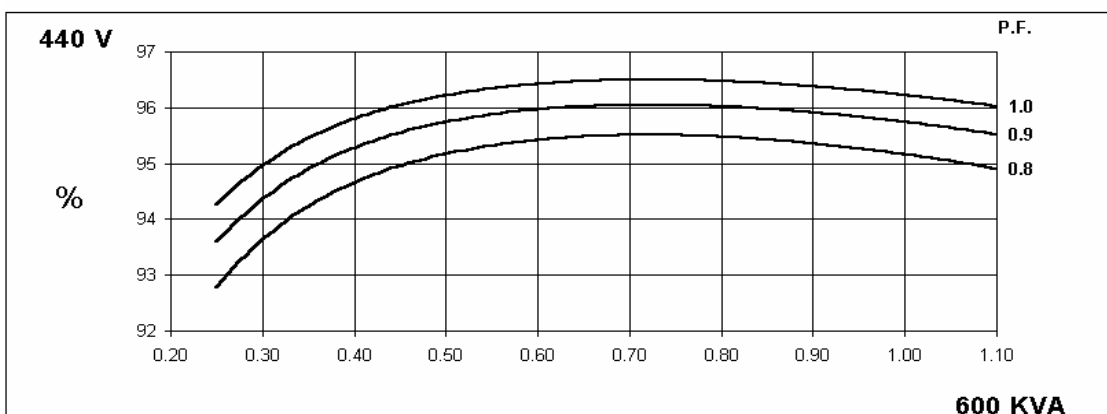
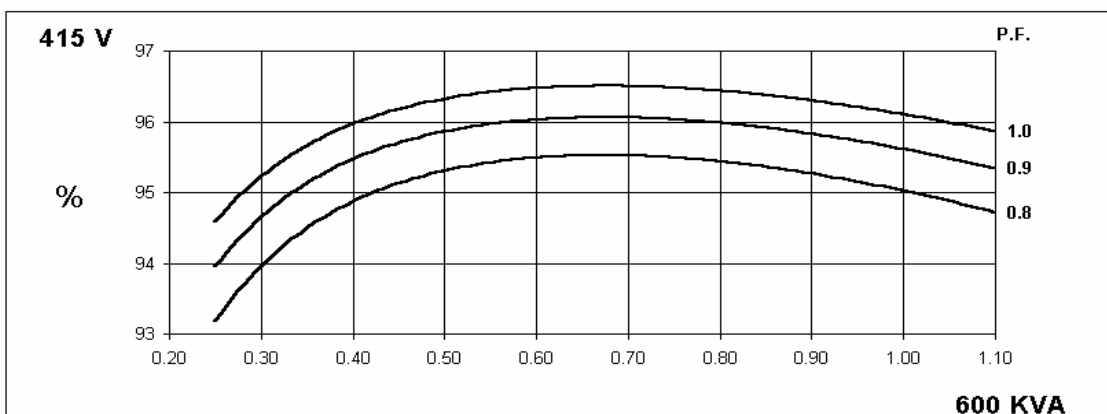
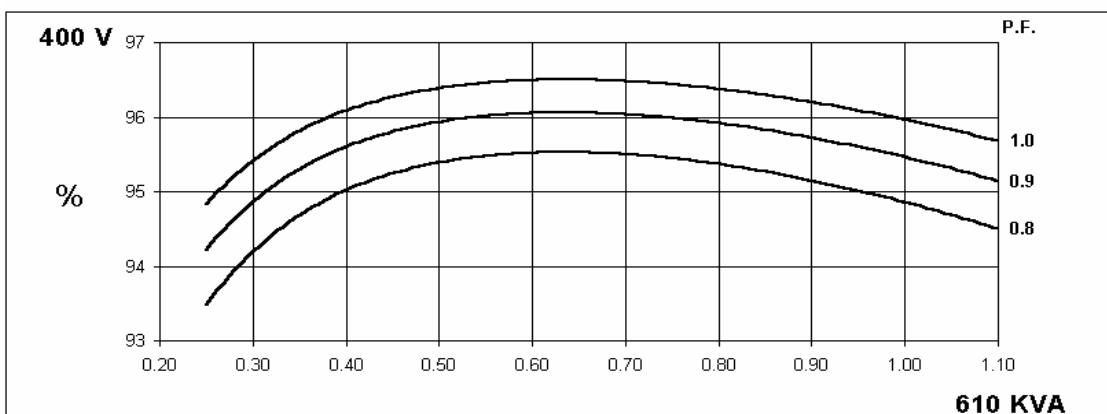
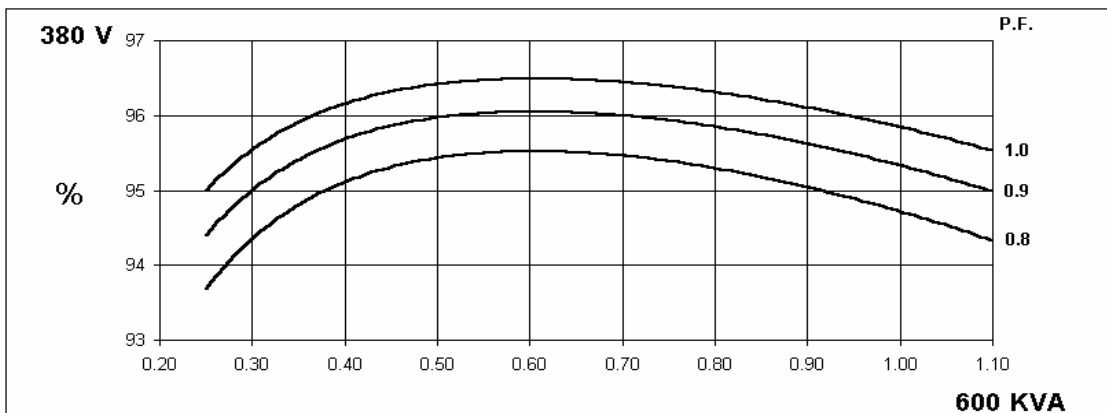

THREE PHASE EFFICIENCY CURVES

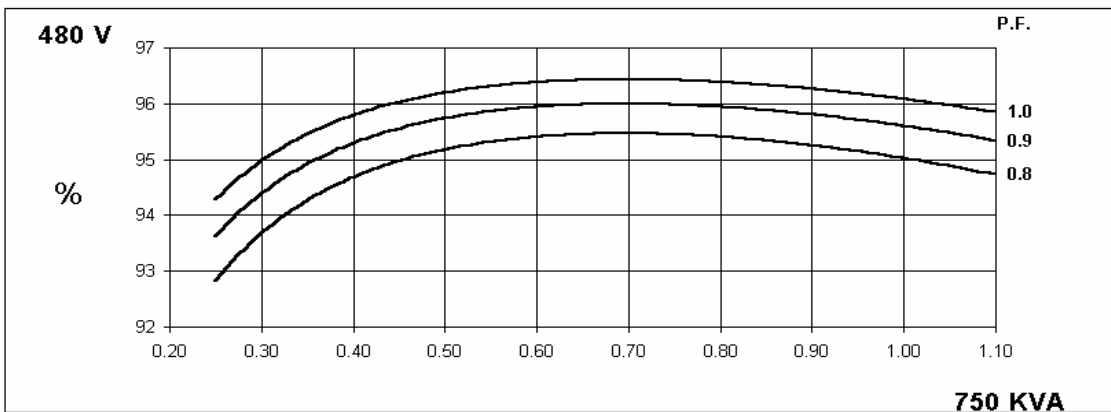
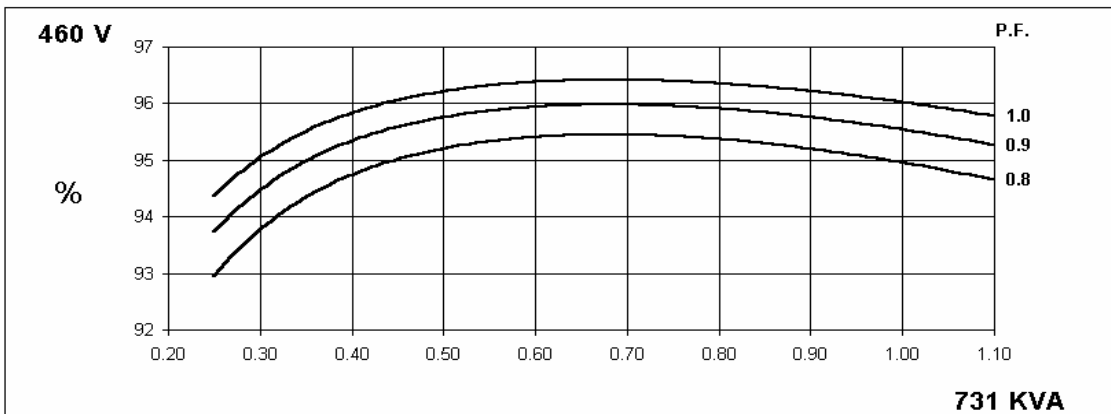
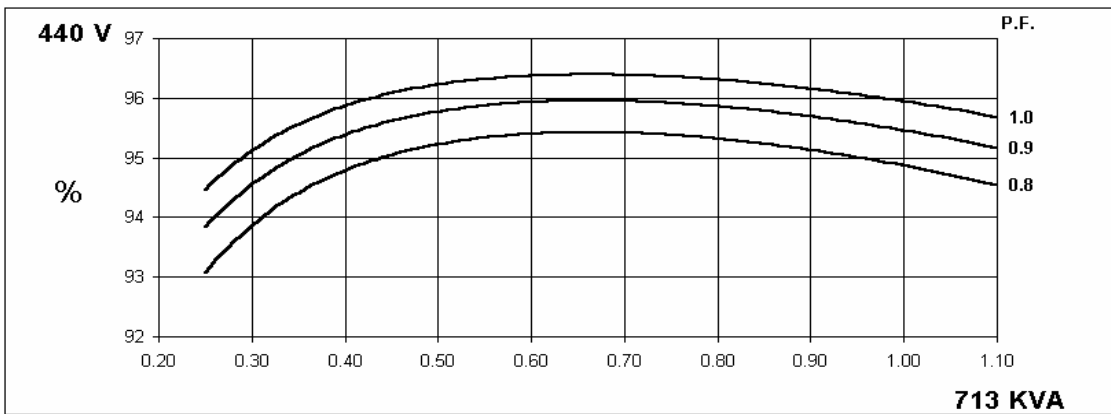
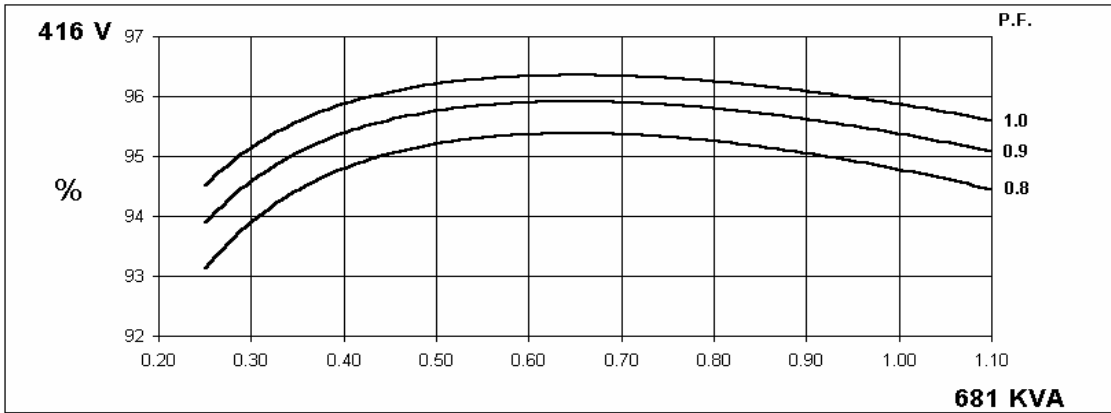

HCI534E/544E

Winding 311



Locked Rotor Motor Starting Curve

**50
Hz**

MX

SX

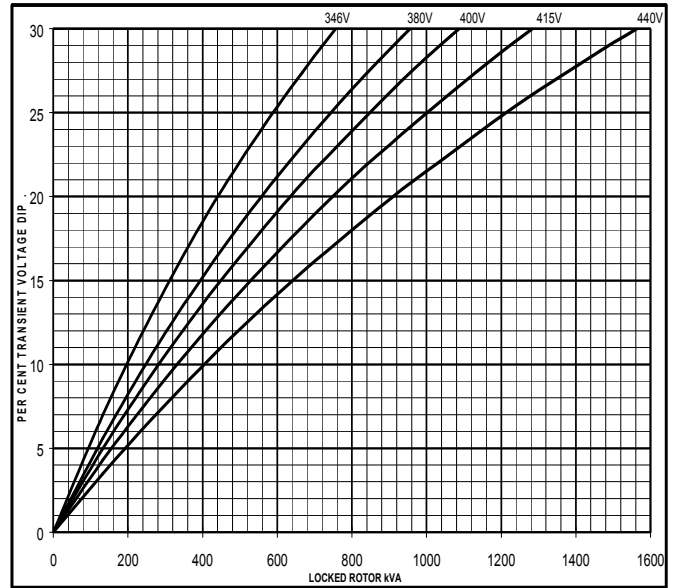
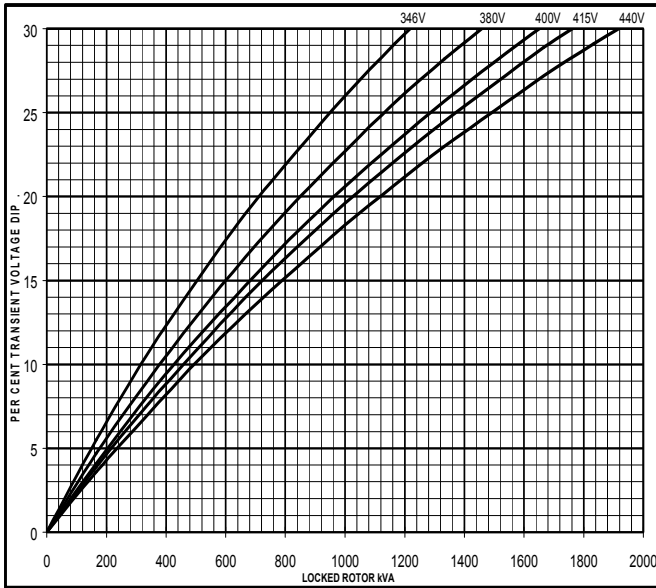

**60
Hz**

MX

SX

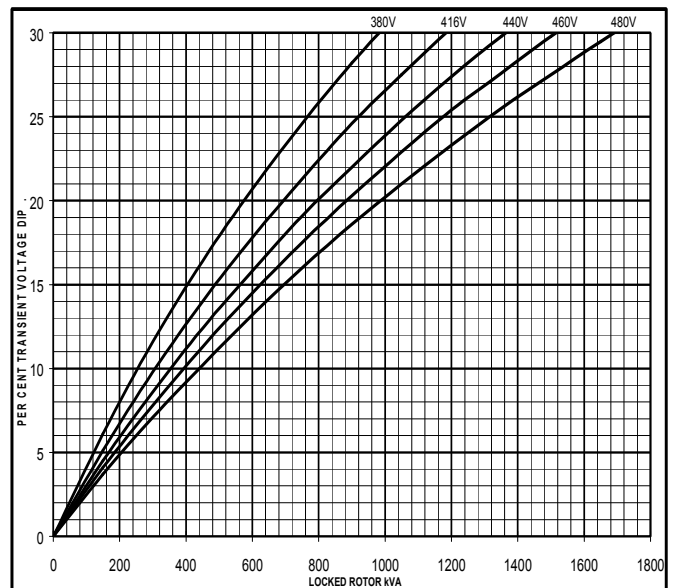
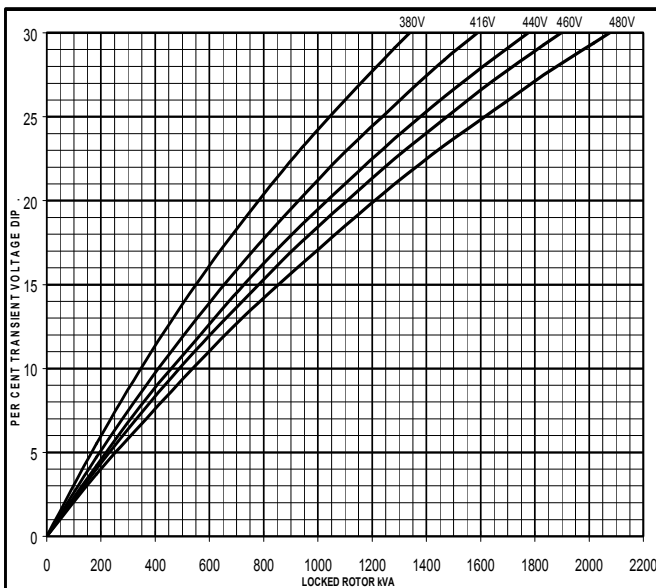

**Three-phase Short Circuit Decrement Curve. No-load Excitation at Rated Speed
Based on star (wye) connection.**

**50
Hz**

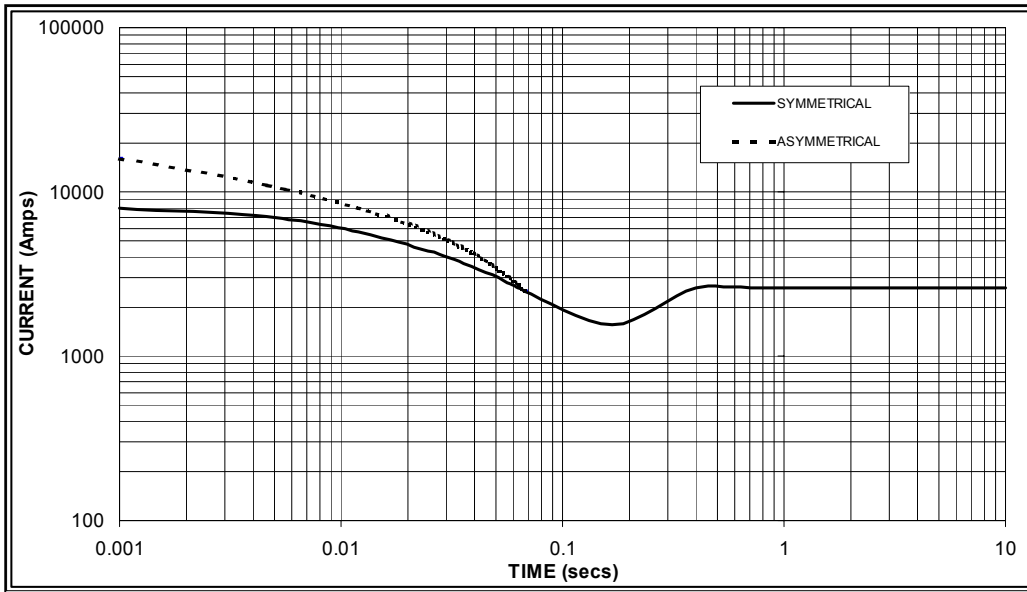

Sustained Short Circuit = 2,600 Amps

**60
Hz**

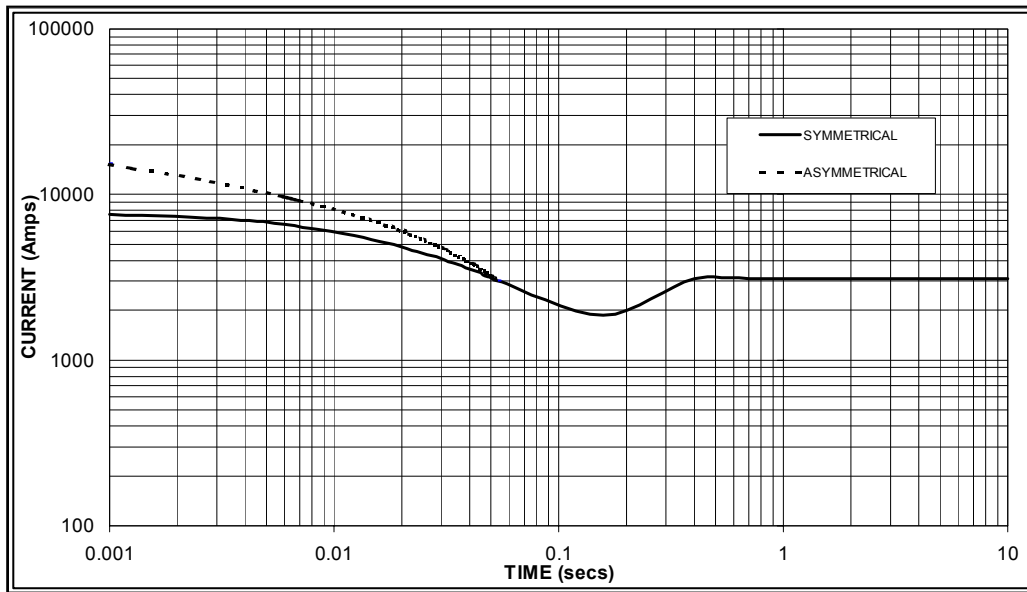

Sustained Short Circuit = 3,100 Amps

Note 1

The following multiplication factors should be used to adjust the values from curve between time 0.001 seconds and the minimum current point in respect of nominal operating voltage :

50Hz		60Hz	
Voltage	Factor	Voltage	Factor
380v	X 1.00	416v	X 1.00
400v	X 1.06	440v	X 1.06
415v	X 1.09	460v	X 1.12
440v	X 1.12	480v	X 1.20

The sustained current value is constant irrespective of voltage level

Note 2

The following multiplication factor should be used to convert the values calculated in accordance with NOTE 1 to those applicable to the various types of short circuit :

	3-phase	2-phase L-L	1-phase L-N
Instantaneous	x 1.00	x 0.87	x 1.30
Minimum	x 1.00	x 1.80	x 3.20
Sustained	x 1.00	x 1.50	x 2.50
Max. sustained duration	10 sec.	5 sec.	2 sec.

All other times are unchanged

Note 3

Curves are drawn for Star (Wye) connected machines. For other connection the following multipliers should be applied to current values as shown :

Parallel Star = Curve current value X 2

Series Delta = Curve current value X 1.732

HCI534E/544E

Winding 311 0.8 Power Factor



RATINGS

Class - Temp Rise	Cont. F - 105/40°C				Cont. H - 125/40°C				Standby - 150/40°C				Standby - 163/27°C				
50 Hz	Series Star (V)	380	400	415	440	380	400	415	440	380	400	415	440	380	400	415	440
	Parallel Star (V)	190	200	208	220	190	200	208	220	190	200	208	220	190	200	208	220
	Series Delta (V)	220	230	240	254	220	230	240	254	220	230	240	254	220	230	240	254
kVA	550	560	550	550	600	610	600	600	636	640	636	636	660	665	660	660	
kW	440	448	440	440	480	488	480	480	509	512	509	509	528	532	528	528	
Efficiency (%)	95.0	95.1	95.2	95.3	94.7	94.9	95.0	95.2	94.5	94.7	94.8	95.0	94.3	94.5	94.7	94.9	
kW Input	463	471	462	462	507	514	505	504	538	541	537	536	560	563	558	556	

60 Hz	Series Star (V)	416	440	460	480	416	440	460	480	416	440	460	480	416	440	460	480
	Parallel Star (V)	208	220	230	240	208	220	230	240	208	220	230	240	208	220	230	240
	Delta (V)	240	254	266	277	240	254	266	277	240	254	266	277	240	254	266	277
kVA	625	650	663	675	681	713	731	750	719	750	780	800	738	769	798	819	
kW	500	520	530	540	545	570	585	600	575	600	624	640	590	615	638	655	
Efficiency (%)	95.0	95.1	95.2	95.3	94.8	94.9	95.0	95.0	94.6	94.7	94.8	94.8	94.5	94.6	94.7	94.8	
kW Input	526	547	557	567	575	601	616	632	608	634	658	675	625	650	674	691	

DIMENSIONS

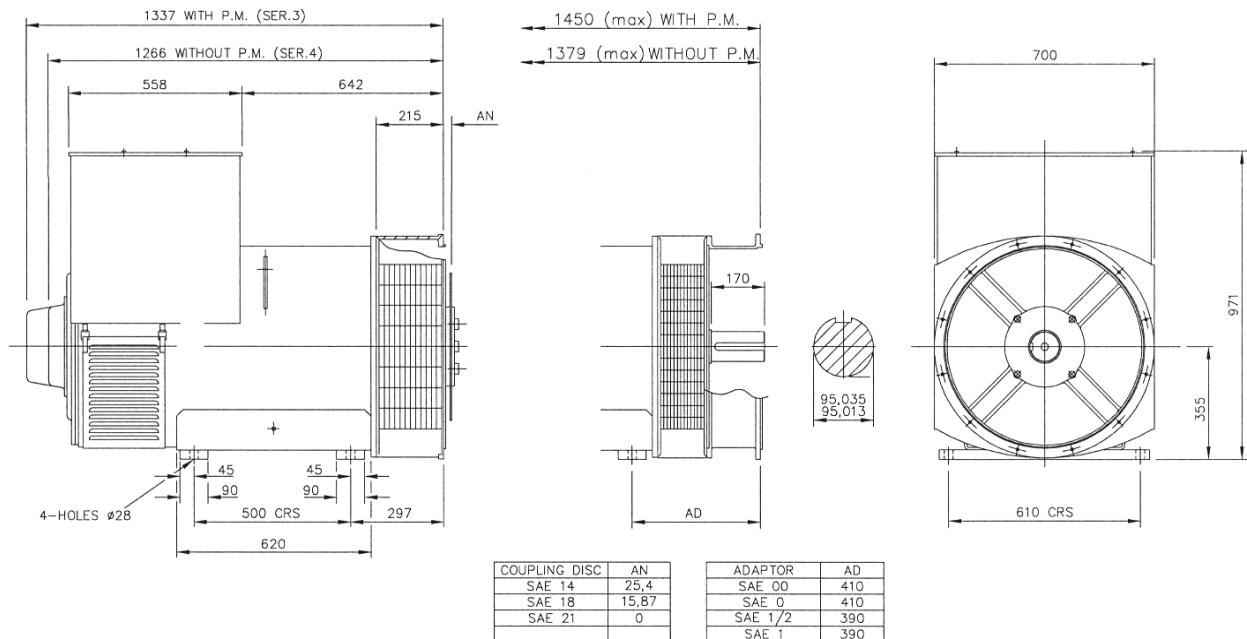

PO Box 17 • Barnack Road • Stamford • Lincolnshire • PE9 2NB

Tel: 00 44 (0)1780 484000 • Fax: 00 44 (0)1780 484100

Website: www.newage-avkseg.com