



ottomotores

DOOSAN Serie P086TI

Energía que Mueve al Mundo

DNY165 / DNY185 / DNY200

Definición

El rendimiento del motor se corresponde con la norma **ISO 3046, BS 5514 y DIN 6271.**

Las clasificaciones se basan en la norma **ISO 8528.** (Si necesita más información, póngase en contacto con la organización de ventas.)

Potencia Prime

Está disponible para un número ilimitado de horas al año en una aplicación de carga variable. La potencia media consumible durante 24 horas de operación no deberá sobrepasar el 70% de la potencia nominal.

Potencia Standby

Está disponible en el caso de un corte de suministro eléctrico o en condiciones de prueba para un máximo de 200 horas de funcionamiento por año. La potencia media consumible durante 24 horas de operación no deberá exceder de 70% de la potencia de reserva.

Tabla de Potencias

Modelo	Voltaje	kVA Prime	kWe Prime	kVA Stand-by	kWe Stand-by
DNY165	440-220V	190	152	206	165
DNY185	440-220V	218	175	233	187
DNY200	440-220V	227	182	250	200

0.8 Factor de Potencia



Datos Técnicos	DNY165	DNY185	DNY200
Motor:	P086TI	P086TI	P086TI
Generador:	Stamford UCI274F	Stamford UCI274G	Stamford UCI274H
Numero de Cilindros	6 en-linea		
Diametro por Carrera:	111(4.37) x 139(5.47) mm(in)		
Relación de Compresión:	16.4:1		
Aspiración:	Turbo y postenfriado (aire - aire)		
Desplazamiento:	8.071(492.49) lts(in ³)		
Consumo a plena carga:	56.8 lts - 100% carga		
Frecuencia:	60 Hz		
Velocidad:	1800 rpm		
Presion Efectiva:	Max. 0.9 kg/cm ² (12.8 psi)		
Flujo de Agua:	150 lts/min.		
Calor rechazado en refrigerante:	20.3 kcal/sec		
Flujo de Aire:	16.8 m ³ /min		
Flujo de Escape:	38.8 m ³ /min		
Temperatura de Escape:	530°C		
Restricciones Max. Permisibles			
Sistema de Admision:	220mmH ² O initial - 635mmH ² O final		
Sistema de Escape:	600mmH ² O max		
Sistema de Aislamiento	Clase H		
Sistema de control:	Autoexcitado		
AVR	SX460		

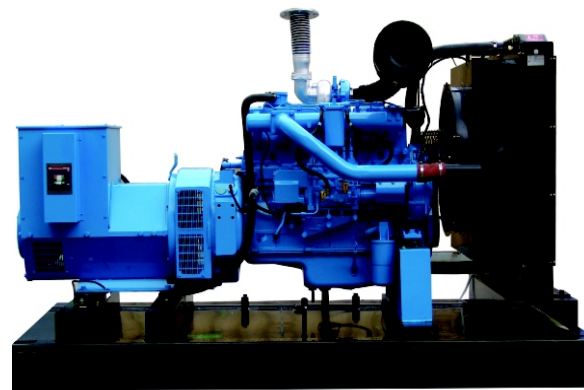

Nota: Imagen de carácter ilustrativa ya que los equipos en foto pudieran incluir accesorios opcionales

Como leer nuestro codigo Ejem: **DNY200**

D = Motor Doosan
N =Generador Newage Stamford
Y = Frecuencia 60Hz-1800 RPM
200 =Potencia del Equipo.

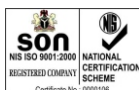

LAPEM

Ottomotores, S.A de C.V.

Calz. San Lorenzo No.1150
Col. Cerro de la estrella, C.P. 09860
Delg. Iztapalapa México, D.F.
Tels:52-55-5624-5600

Fax: 52-55-5426-5521 / 52-55-5426-5581
email sales : ventas@ottomotores.com.mx
sitio web: www.ottomotores.com.mx

Dimensiones

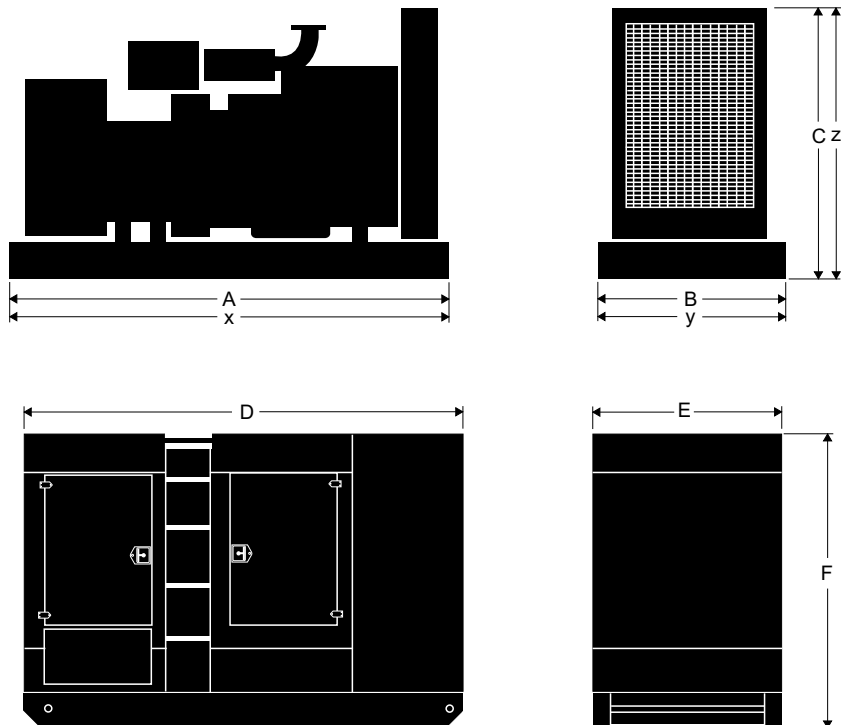

C.pack	Equipo con Base Estructural			Equipo con Base Tanque			Equipo con Caseta Acústica*		
	A	B	C	x	y	z	D	E	F
	260,00	93,00	150,50	280,00	145,00	173,00	343,00	145,00	190,00
	Peso: 1583,00kgs			Peso: 2097,00 kgs			Peso: 2730,00 kgs		

[*] optional

Información Técnica

Nota: las condiciones de referencia estándar son de 25 °C (77 ° F) temperatura de entrada de aire. Todos los datos de desempeño de motores son basados en la potencia mencionada arriba.

Datos de consumo de combustible a plena carga con combustible diesel tienen una gravedad específica de 0,85.

Comercializado por:

Módulos de Control



Ottomotores tiene una posición única en la fabricación de grupos electrógenos utilizando en ellos módulos de control que cumplen con todos los niveles de requerimiento del mercado nacional y de exportación.



Las diferentes soluciones de controles que se tienen para nuestra gama de plantas generadoras, permite una operación simple en modo manual y automático, así mismo permiten desarrollar proyectos de sincronía entre plantas generadoras o con la red de energía eléctrica.



La familia de módulos de control en transición abierta (DALE 3200) permite tener control en forma automática de la unidad de transferencia, así como el monitoreo del grupo generador.



Nuestro módulos de control cuentan con puerto de comunicación RS485 para la comunicación remota con el grupo generador.



La familia de módulos de control para la sincronía (6100, 6050 y 6300), incorporan un amplio sistema de monitoreos además de conexión a Internet (LAN) o mensaje SMS via celular, o usando los puertos de comunicación RS485 a través de ModBus



ottomotores

Energía que Mueve al Mundo

Calz. San Lorenzo No.1150
Col. Cerro de la Estrella, C.P.09860
Delegación Iztapalapa México D.F.
Tels: 52-55-5624-5600
Fax.52-55-5426-55-21 / 52-55-54265581

E-mail ventas1@ottomotores.com.mx
ventas2@ottomotores.com.mx

Web site. www.ottomotores.com.mx

© Ottomotores se reserva el derecho de hacer cambios sin previo aviso con el fin de mejorar nuestros productos 2010

◎ POWER RATING

Engine Speed rev/min	Type of Operation	Engine Power	
		kWm	Ps
1800	Continuous Power	186	253
	Prime Power	205	279
	Standby Power	223	303
1500	Continuous Power	151	205
	Prime Power	177	240
	Standby Power	199	270

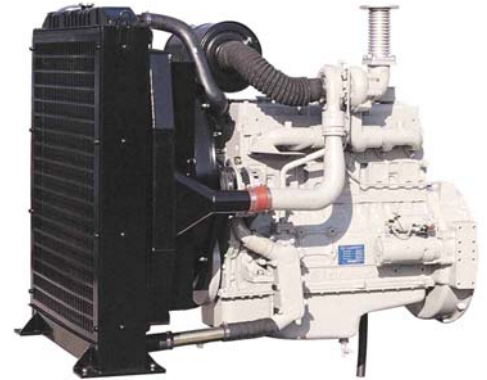

Note : -. The engine performance corresponds to ISO 3046, BS 5514 and DIN 6271.

-. Ratings are based on ISO 8528.

→ **Prime power** available at variable load. The permissible average power out put (during 24h period) shall not exceed 70% of the prime power rating.

→ **Standby power** available in the event of a main power network failure. No overload is permitted.

◎ MECHANICAL SYSTEM

○ Engine Model	P086TI
○ Engine Type	In-line 4 cycle, water cooled Turbo charged & intercooled (air to air)
○ Combustion type	Direct injection
○ Cylinder Type	Replaceable dry liner
○ Number of cylinders	6
○ Bore x stroke	111(4.37) x 139(5.47) mm(in.)
○ Displacement	8.071(492.49) lit.(in ³)
○ Compression ratio	16.4 : 1
○ Firing order	1-5-3-6-2-4
○ Injection timing	12° BTDC
○ Compression pressure	Above 28 kg/cm ² (398 psi) at 200rpm
○ Dry weight	Approx. 790 kg (1,742 lb)
○ Dimension (LxWxH)	1,242 x 918 x 1,099.5 mm (48.9 x 36.1 x 43.3 in.)
○ Rotation	Counter clockwise viewed from Flywheel
○ Fly wheel housing	SAE NO.1
○ Fly wheel	Clutch NO.14

◎ MECHANISM

○ Type	Over head valve
○ Number of valve	Intake 1, exhaust 1 per cylinder
○ Valve lashes at cold	Intake 0.30mm (0.0118 in.) Exhaust 0.30mm (0.0118 in.)

◎ VALVE TIMING

	Opening	Close
○ Intake valve	16 deg. BTDC	36 deg. ABDC
○ Exhaust valve	46 deg. BBDC	14 deg. ATDC

◎ FUEL CONSUMPTION

○ Prime Power (lit/hr)	1,500 rpm	1,800 rpm
25%	11.3	13.8
50%	21.1	25.1
75%	31.7	37.7
100%	43.1	50.6
○ Standby Power (lit/h)	1,500 rpm	1,800 rpm
25%	12.7	15.2
50%	23.7	27.7
75%	35.5	41.6
100%	48.4	56.8

◎ FUEL SYSTEM

○ Injection pump	Zexel in-line "P" type
○ Governor	Electric type
○ Feed pump	Mechanical type
○ Injection nozzle	Multi hole type
○ Opening pressure	224 kg/cm ² (3,186 psi)
○ Fuel filter	Full flow, cartridge type
○ Used fuel	Diesel fuel oil

◎ LUBRICATION SYSTEM

○ Lub. Method	Fully forced pressure feed type
○ Oil pump	Gear type driven by crankshaft
○ Oil filter	Full flow, cartridge type
○ Oil pan capacity	High level 15.5 liters (4.09 gal.) Low level 12 liters (3.17 gal.)
○ Angularity limit	Front down 25 deg. Front up 25 deg. Side to side 25 deg.
○ Lub. Oil	Refer to Operation Manual

◎ COOLING SYSTEM

- Cooling method Fresh water forced circulation
- Water capacity 14 liters (3.70 gal.)
(engine only)
- Pressure system Max. 0.9 kg/cm² (12.8 psi)
- Water pump Centrifugal type driven by belt
- Water pump Capacity 150 liters (39.6 gal.)/min
at 1,800 rpm (engine)
- Thermostat Wax – pellet type
Opening temp. 71°C
Full open temp. 85°C
- Cooling fan Blower type, plastic
660.4 mm diameter, 7 blade

◎ ELECTRICAL SYSTEM

- Charging generator 24V x 45A alternator
- Voltage regulator Built-in type IC regulator
- Starting motor 24V x 6.0kW
- Battery Voltage 24V
- Battery Capacity 100 AH (recommended)
- Starting aid (Option) Block heater

◎ ENGINEERING DATA

- | | |
|-----------------------------|-------------------------------------|
| ○ Water flow | 130 liters/min @1,500 rpm |
| ○ Heat rejection to coolant | 17.3 kcal/sec @1,500 rpm |
| ○ Heat rejection to CAC | 4.5 kcal/sec @1,500 rpm |
| ○ Air flow | 12.1 m ³ /min @1,500 rpm |
| ○ Exhaust gas flow | 33.9 m ³ /min @1,500 rpm |
| ○ Exhaust gas temp. | 580 °C @1,500 rpm |
-
- | | |
|-----------------------------|-------------------------------------|
| ○ Water flow | 150 liters/min @1,800 rpm |
| ○ Heat rejection to coolant | 20.3 kcal/sec @1,800 rpm |
| ○ Heat rejection to CAC | 10.8 kcal/sec @1,800 rpm |
| ○ Air flow | 16.8 m ³ /min @1,800 rpm |
| ○ Exhaust gas flow | 38.8 m ³ /min @1,800 rpm |
| ○ Exhaust gas temp. | 530 °C @1,800 rpm |
-
- Max. permissible restrictions
 - .Intake system 220 mmH₂O initial
635 mmH₂O final
 - .Exhaust system 600 mmH₂O max.

◆ CONVERSION TABLE

- | | |
|------------------------------------|------------------------------------|
| in. = mm x 0.0394 | lb/ft = N.m x 0.737 |
| PS = kW x 1.3596 | U.S. gal = lit. x 0.264 |
| psi = kg/cm ² x 14.2233 | kW = 0.2388 kcal/s |
| in ³ = lit. x 61.02 | lb/PS.h = g/kW.h x 0.00162 |
| hp = PS x 0.98635 | cfm = m ³ /min x 35.336 |
| lb = kg x 2.20462 | |

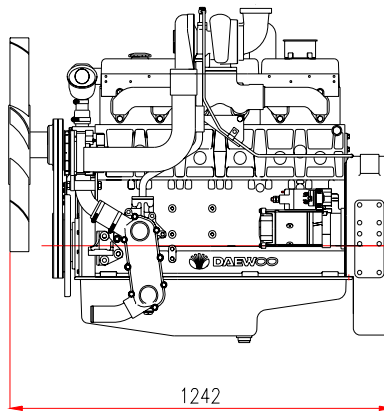
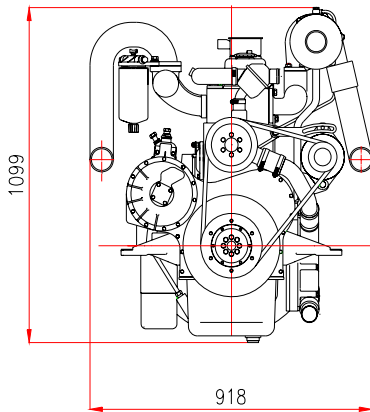

Head office

7-11, Hwasu-Dong, Dong-Gu, Incheon, Korea
TEL : 82-32-760-1437, 1964 FAX : 82-32-760-1964

Seoul Office

Doosan Infracore Co. Ltd.,
 22nd Floor, Doosan Tower, 18-12, Euljiro 6-ga, Jung-gu,
 Seoul, Korea.

TEL : 82-2-3398-8521~8535 FAX : 82-2-3398-8509

Web site : www.doosaninfracore.com

※ Specifications are subject to change without prior notice

UCI274G - Technical Data Sheet

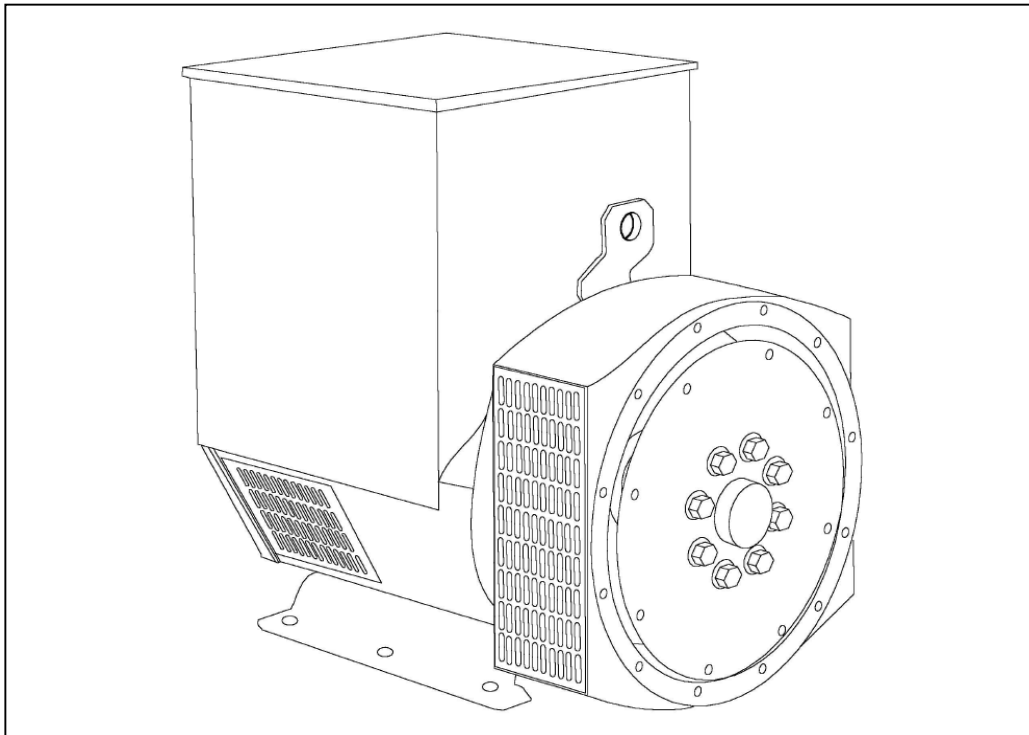

UCI274G

SPECIFICATIONS & OPTIONS



STANDARDS

Newage Stamford industrial generators meet the requirements of BS EN 60034 and the relevant section of other international standards such as BS5000, VDE 0530, NEMA MG1-32, IEC34, CSA C22.2-100, AS1359. Other standards and certifications can be considered on request.

VOLTAGE REGULATORS

SX460 AVR - STANDARD

With this self excited control system the main stator supplies power via the Automatic Voltage Regulator (AVR) to the exciter stator. The high efficiency semiconductors of the AVR ensure positive build-up from initial low levels of residual voltage.

The exciter rotor output is fed to the main rotor through a three phase full wave bridge rectifier. This rectifier is protected by a surge suppressor against surges caused, for example, by short circuit.

SX440 AVR

With this self-excited system the main stator provides power via the AVR to the exciter stator. The high efficiency semi-conductors of the AVR ensure positive build-up from initial low levels of residual voltage.

The exciter rotor output is fed to the main rotor through a three-phase full-wave bridge rectifier. The rectifier is protected by a surge suppressor against surges caused, for example, by short circuit or out-of-phase paralleling.

The SX440 will support a range of electronic accessories, including a 'droop' Current Transformer (CT) to permit parallel operation with other ac generators.

If 3-phase sensing is required with the self-excited system, the SX421 AVR must be used.

SX421AVR

This AVR also operates in a self-excited system. It combines all the features of the SX440 with, additionally, three-phase rms sensing for improved regulation and performance. Over voltage protection is provided via a separate circuit breaker. An engine relief load acceptance feature is built in as standard.

MX341 AVR

This sophisticated AVR is incorporated into the Stamford Permanent Magnet Generator (PMG) control system.

The PMG provides power via the AVR to the main exciter, giving a source of constant excitation power independent of generator output. The main exciter output is then fed to the main rotor, through a full wave bridge, protected by a surge suppressor. The AVR has in-built protection against sustained over-excitation, caused by internal or external faults. This de-excites the machine after a minimum of 5 seconds.

An engine relief load acceptance feature can enable full load to be applied to the generator in a single step.

If three-phase sensing is required with the PMG system the MX321 AVR must be used.

We recommend three-phase sensing for applications with greatly unbalanced or highly non-linear loads.

MX321 AVR

The most sophisticated of all our AVRs combines all the features of the MX341 with, additionally, three-phase rms sensing, for improved regulation and performance.

Over voltage protection is built-in and short circuit current level adjustments is an optional facility.

WINDINGS & ELECTRICAL PERFORMANCE

All generator stators are wound to 2/3 pitch. This eliminates triplen (3rd, 9th, 15th ...) harmonics on the voltage waveform and is found to be the optimum design for trouble-free supply of non-linear loads. The 2/3 pitch design avoids excessive neutral currents sometimes seen with higher winding pitches, when in parallel with the mains. A fully connected damper winding reduces oscillations during paralleling. This winding, with the 2/3 pitch and carefully selected pole and tooth designs, ensures very low waveform distortion.

TERMINALS & TERMINAL BOX

Standard generators are 3-phase reconnectable with 12 ends brought out to the terminals, which are mounted on a cover at the non-drive end of the generator. A sheet steel terminal box contains the AVR and provides ample space for the customers' wiring and gland arrangements. It has removable panels for easy access.

SHAFT & KEYS

All generator rotors are dynamically balanced to better than BS6861:Part 1 Grade 2.5 for minimum vibration in operation. Two bearing generators are balanced with a half key.

INSULATION/IMPREGNATION

The insulation system is class 'H'.

All wound components are impregnated with materials and processes designed specifically to provide the high build required for static windings and the high mechanical strength required for rotating components.

QUALITY ASSURANCE

Generators are manufactured using production procedures having a quality assurance level to BS EN ISO 9001.

The stated voltage regulation may not be maintained in the presence of certain radio transmitted signals. Any change in performance will fall within the limits of Criteria 'B' of EN 61000-6-2:2001. At no time will the steady-state voltage regulation exceed 2%.

NB Continuous development of our products entitles us to change specification details without notice, therefore they must not be regarded as binding.

Front cover drawing typical of product range.

UCI274G WINDING 311

CONTROL SYSTEM		SEPARATELY EXCITED BY P.M.G.							
A.V.R.		MX321	MX341						
VOLTAGE REGULATION		± 0.5 %	± 1.0 %	With 4% ENGINE GOVERNING					
SUSTAINED SHORT CIRCUIT		REFER TO SHORT CIRCUIT DECREMENT CURVES (page 7)							
CONTROL SYSTEM		SELF EXCITED							
A.V.R.		SX460	SX440	SX421					
VOLTAGE REGULATION		± 1.5 %	± 1.0 %	± 0.5 %	With 4% ENGINE GOVERNING				
SUSTAINED SHORT CIRCUIT		SERIES 4 CONTROL DOES NOT SUSTAIN A SHORT CIRCUIT CURRENT							
INSULATION SYSTEM		CLASS H							
PROTECTION		IP23							
RATED POWER FACTOR		0.8							
STATOR WINDING		DOUBLE LAYER CONCENTRIC							
WINDING PITCH		TWO THIRDS							
WINDING LEADS		12							
STATOR WDG. RESISTANCE		0.0199 Ohms PER PHASE AT 22°C SERIES STAR CONNECTED							
ROTOR WDG. RESISTANCE		1.69 Ohms at 22°C							
R.F.I. SUPPRESSION		BS EN 61000-6-2 & BS EN 61000-6-4, VDE 0875G, VDE 0875N. refer to factory for others							
WAVEFORM DISTORTION		NO LOAD < 1.5% NON-DISTORTING BALANCED LINEAR LOAD < 5.0%							
MAXIMUM OVERSPEED		2250 Rev/Min							
BEARING DRIVE END		BALL. 6315-2RS (ISO)							
BEARING NON-DRIVE END		BALL. 6310-2RS (ISO)							
		1 BEARING				2 BEARING			
WEIGHT COMP. GENERATOR		580 kg				598 kg			
WEIGHT WOUND STATOR		225 kg				225 kg			
WEIGHT WOUND ROTOR		210.35 kg				199.39 kg			
WR ² INERTIA		1.7674 kgm ²				1.7169 kgm ²			
SHIPPING WEIGHTS in a crate		613 kg				630 kg			
PACKING CRATE SIZE		123 x 67 x 103 (cm)				123 x 67 x 103 (cm)			
		50 Hz				60 Hz			
TELEPHONE INTERFERENCE		THF<2%				TIF<50			
COOLING AIR		0.514 m ³ /sec 1090 cfm				0.617 m ³ /sec 1308 cfm			
VOLTAGE SERIES STAR		380/220	400/231	415/240	440/254	416/240	440/254	460/266	480/277
VOLTAGE PARALLEL STAR		190/110	200/115	208/120	220/127	208/120	220/127	230/133	240/138
VOLTAGE SERIES DELTA		220/110	230/115	240/120	254/127	240/120	254/127	266/133	277/138
KVA BASE RATING FOR REACTANCE VALUES		180	180	180	n/a	205	218	218	231
Xd DIR. AXIS SYNCHRONOUS		2.12	1.92	1.78	-	2.43	2.31	2.11	2.06
X'd DIR. AXIS TRANSIENT		0.18	0.17	0.16	-	0.21	0.20	0.18	0.18
X''d DIR. AXIS SUBTRANSIENT		0.13	0.12	0.11	-	0.15	0.14	0.13	0.12
Xq QUAD. AXIS REACTANCE		1.28	1.15	1.07	-	1.47	1.40	1.28	1.24
X''q QUAD. AXIS SUBTRANSIENT		0.17	0.16	0.15	-	0.18	0.17	0.16	0.15
Xl LEAKAGE REACTANCE		0.08	0.07	0.07	-	0.09	0.08	0.08	0.07
X2 NEGATIVE SEQUENCE		0.13	0.12	0.11	-	0.16	0.15	0.13	0.13
X0 ZERO SEQUENCE		0.08	0.07	0.07	-	0.10	0.09	0.08	0.08
REACTANCES ARE SATURATED				VALUES ARE PER UNIT AT RATING AND VOLTAGE INDICATED					
T'd TRANSIENT TIME CONST.		0.038 s							
T''d SUB-TRANSTIME CONST.		0.012 s							
T'do O.C. FIELD TIME CONST.		1 s							
Ta ARMATURE TIME CONST.		0.01 s							
SHORT CIRCUIT RATIO		1/Xd							

**50
Hz**

UCI274G
Winding 311



THREE PHASE EFFICIENCY CURVES

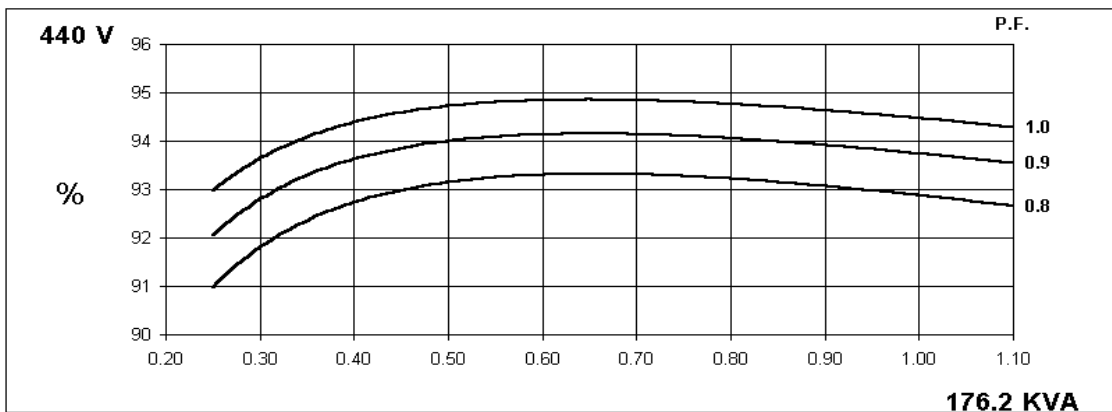
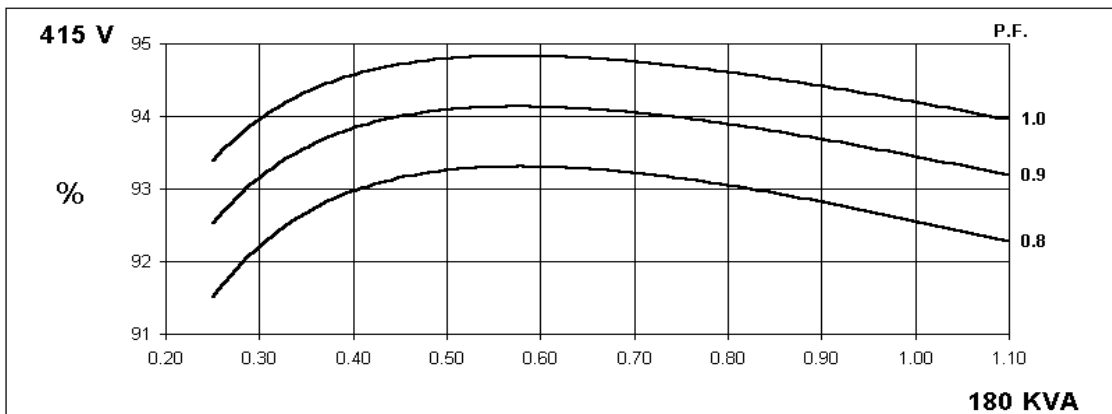
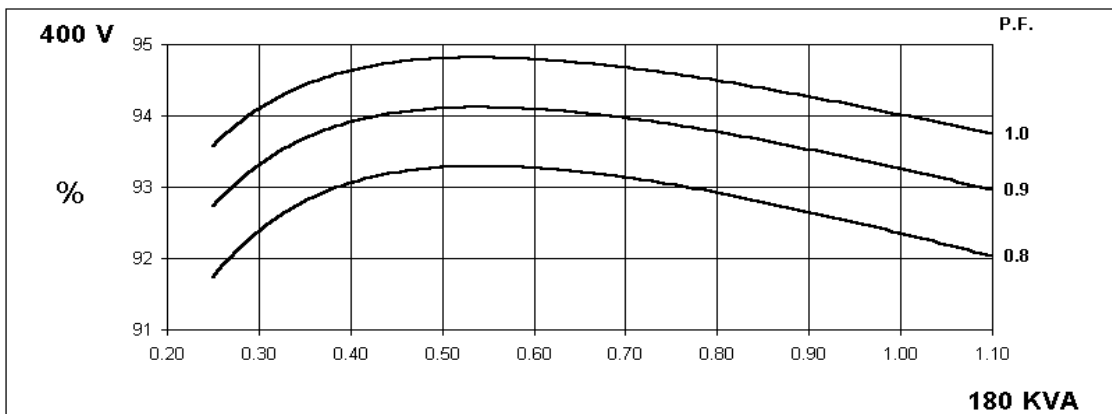
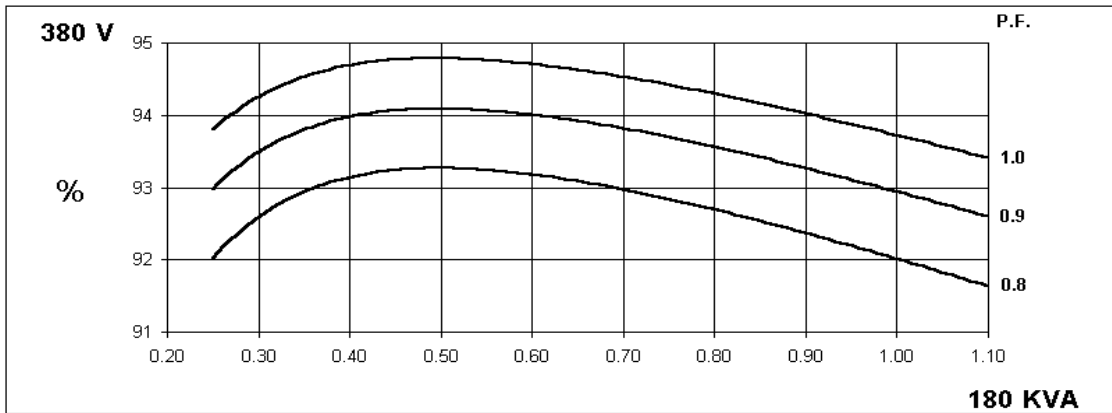

THREE PHASE EFFICIENCY CURVES

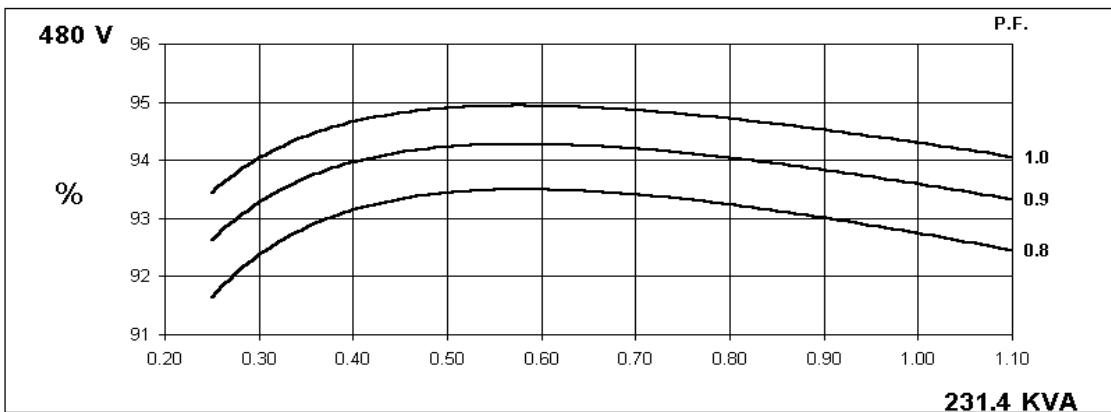
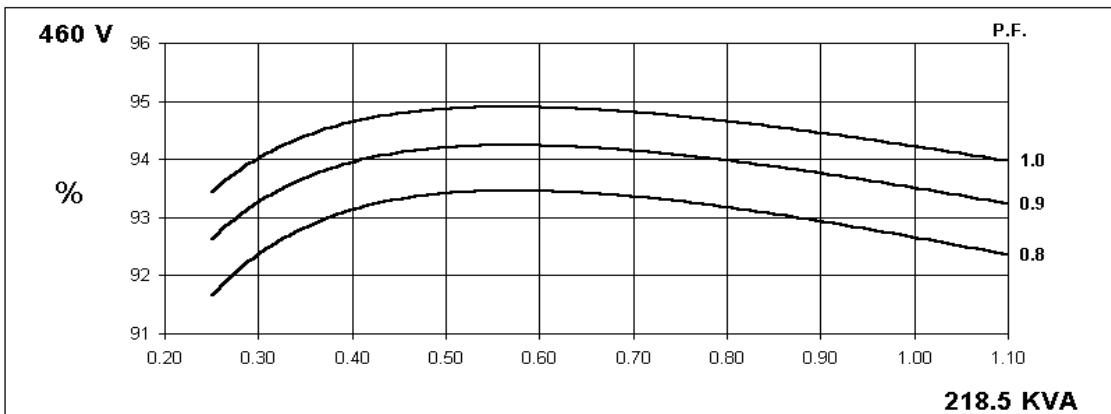
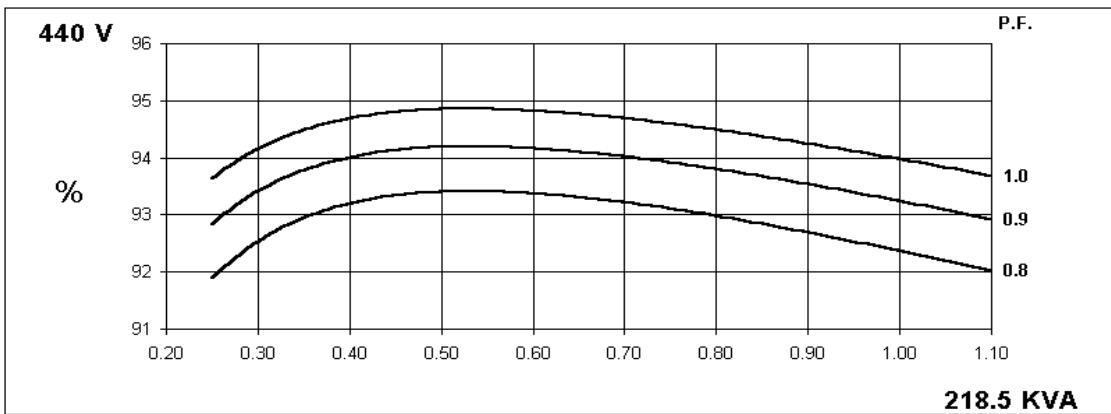
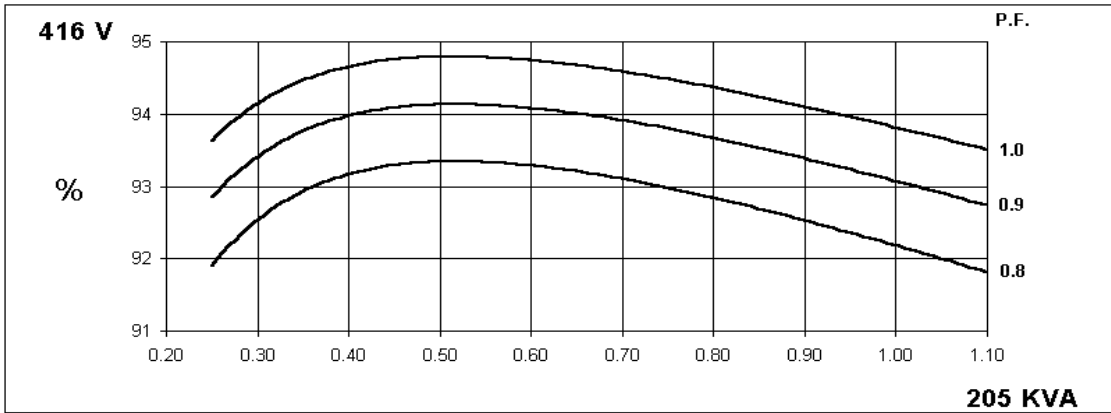

UCI274G

Winding 311



Locked Rotor Motor Starting Curve

**50
Hz**

MX

SX

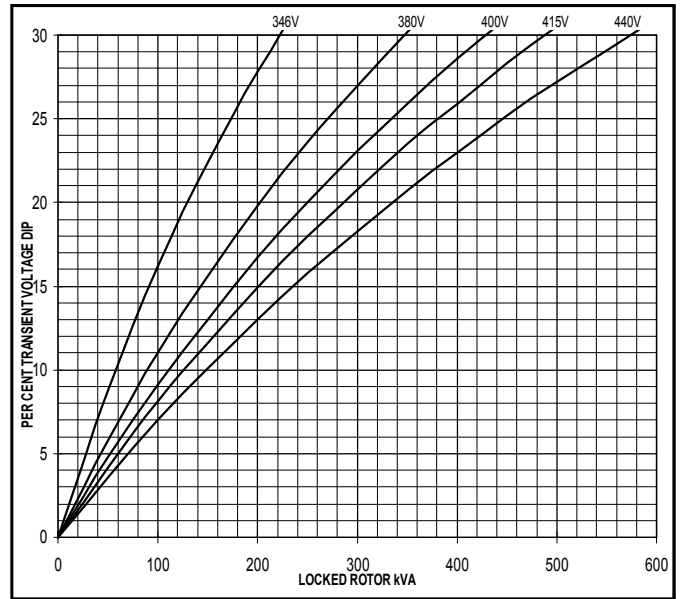
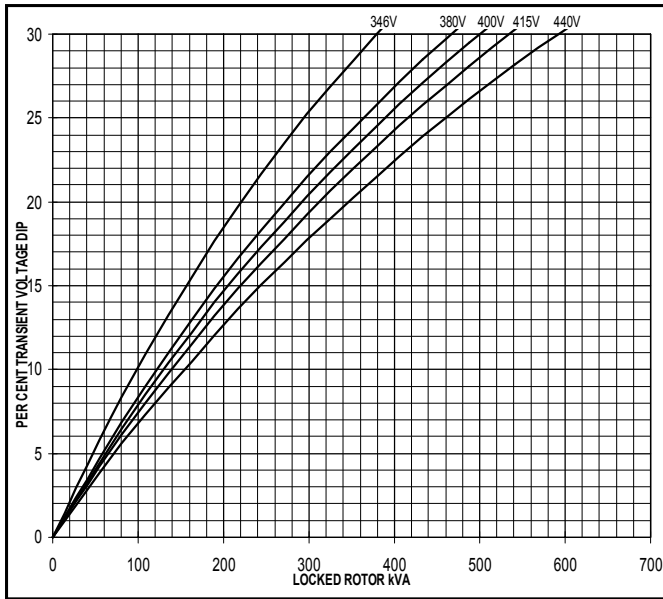

**60
Hz**

MX

SX

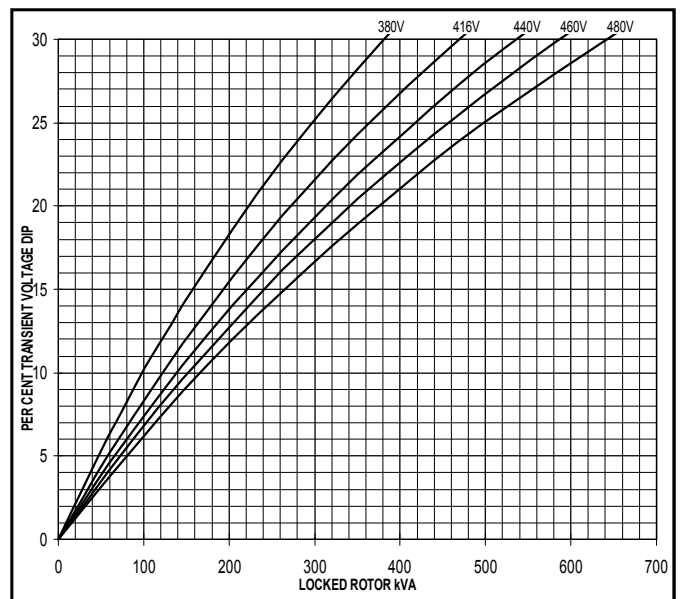
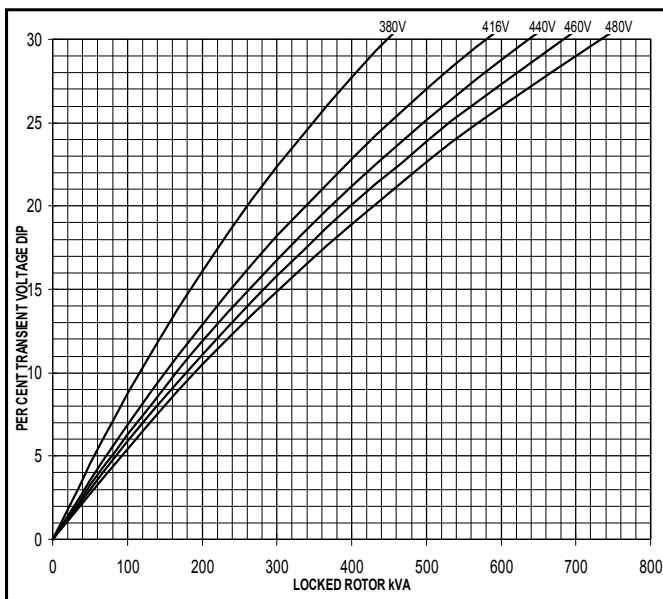

**Three-phase Short Circuit Decrement Curve. No-load Excitation at Rated Speed
Based on star (wye) connection.**

**50
Hz**

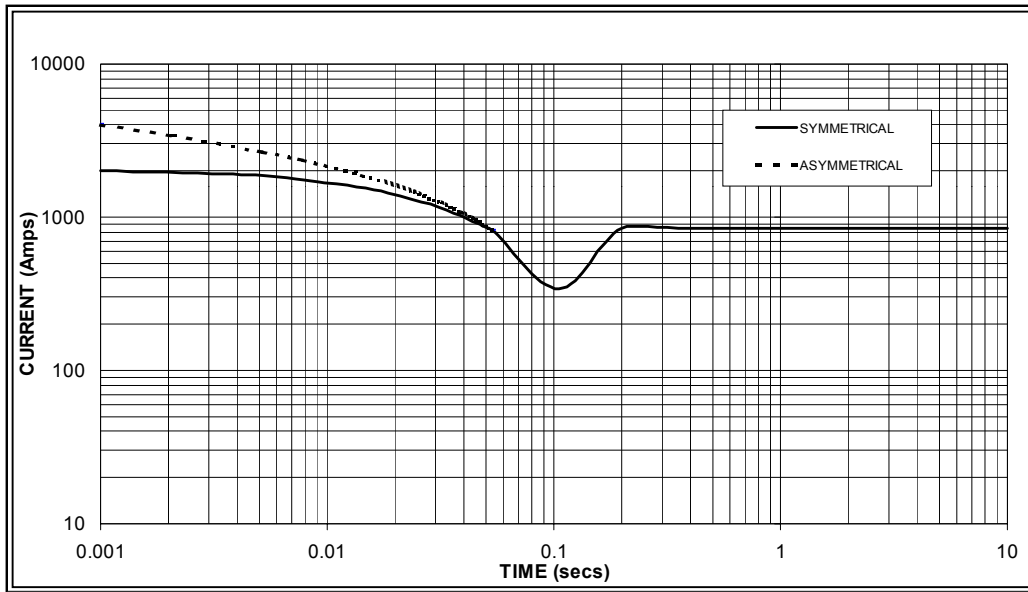

Sustained Short Circuit = 850 Amps

**60
Hz**

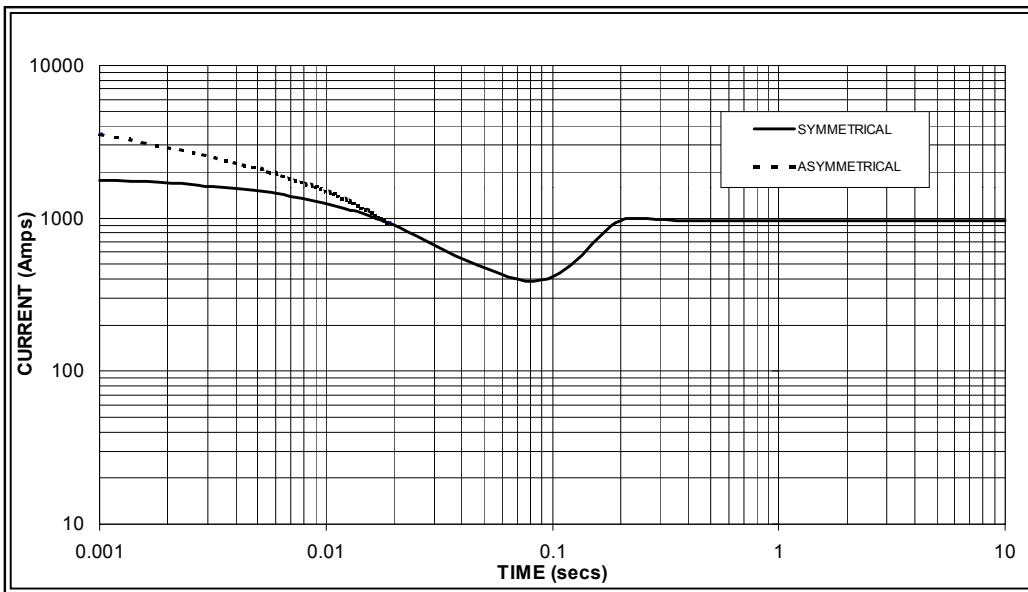

Sustained Short Circuit = 970 Amps

Note 1

The following multiplication factors should be used to adjust the values from curve between time 0.001 seconds and the minimum current point in respect of nominal operating voltage :

50Hz		60Hz	
Voltage	Factor	Voltage	Factor
380v	X 1.00	416v	X 1.00
400v	X 1.07	440v	X 1.06
415v	X 1.12	460v	X 1.12
440v	X 1.18	480v	X 1.17

The sustained current value is constant irrespective of voltage level

Note 2

The following multiplication factor should be used to convert the values calculated in accordance with NOTE 1 to those applicable to the various types of short circuit :

	3-phase	2-phase L-L	1-phase L-N
Instantaneous	x 1.00	x 0.87	x 1.30
Minimum	x 1.00	x 1.80	x 3.20
Sustained	x 1.00	x 1.50	x 2.50
Max. sustained duration	10 sec.	5 sec.	2 sec.

All other times are unchanged

Note 3

Curves are drawn for Star (Wye) connected machines. For other connection the following multipliers should be applied to current values as shown :

Parallel Star = Curve current value X 2

Series Delta = Curve current value X 1.732

UCI274G

Winding 311 / 0.8 Power Factor



RATINGS

Class - Temp Rise	Cont. F - 105/40°C				Cont. H - 125/40°C				Standby - 150/40°C				Standby - 163/27°C				
50 Hz	Series Star (V)	380	400	415	440	380	400	415	440	380	400	415	440	380	400	415	440
	Parallel Star (V)	190	200	208	220	190	200	208	220	190	200	208	220	190	200	208	220
	Series Delta (V)	220	230	240	254	220	230	240	254	220	230	240	254	220	230	240	254
kVA	164.6	164.6	164.6	n/a	180.0	180.0	180.0	n/a	187.0	187.0	187.0	n/a	194.0	194.0	194.0	n/a	
kW	131.7	131.7	131.7	n/a	144.0	144.0	144.0	n/a	149.6	149.6	149.6	n/a	155.2	155.2	155.2	n/a	
Efficiency (%)	92.3	92.6	92.8	n/a	92.0	92.4	92.6	n/a	91.9	92.2	92.5	n/a	91.7	92.1	92.3	n/a	
kW Input	142.7	142.2	141.9	n/a	156.5	155.8	155.5	n/a	162.8	162.3	161.7	n/a	169.2	168.5	168.1	n/a	

60 Hz	Series Star (V)	416	440	460	480	416	440	460	480	416	440	460	480	416	440	460	480
	Parallel Star (V)	208	220	230	240	208	220	230	240	208	220	230	240	208	220	230	240
	Series Delta (V)	240	254	266	277	240	254	266	277	240	254	266	277	240	254	266	277
kVA	192.8	199.0	199.0	212.2	205.0	218.5	218.5	231.4	213.0	228.8	228.8	246.8	218.5	234.0	234.0	253.3	
kW	154.2	159.2	159.2	169.8	164.0	174.8	174.8	185.1	170.4	183.0	183.0	197.4	174.8	187.2	187.2	202.6	
Efficiency (%)	92.4	92.7	92.9	93.0	92.2	92.4	92.7	92.7	92.0	92.2	92.5	92.6	91.9	92.1	92.4	92.5	
kW Input	166.9	171.7	171.4	182.5	177.9	189.2	188.6	199.7	185.2	198.5	197.9	213.2	190.2	203.3	202.6	219.1	

DIMENSIONS

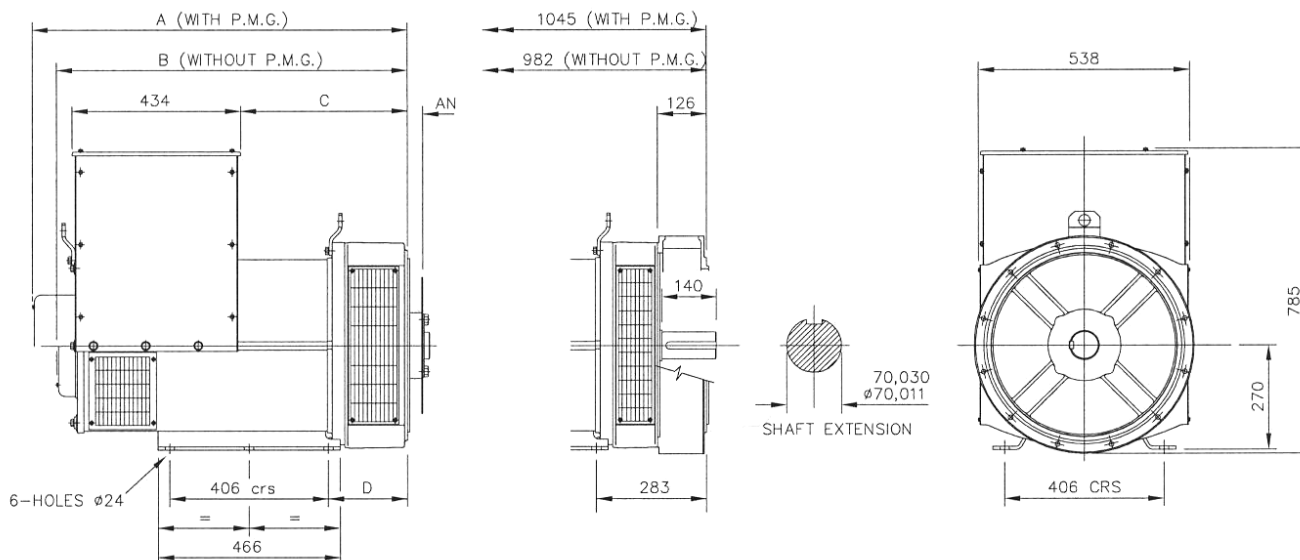

SINGLE BEARING ADAPTORS				
ADAPTOR	A	B	C	D
SAE 1	978,3	915,3	439,3	216,3
SAE 2	964	901	425	202
SAE 3	964	901	425	202

COUPLING DISCS	
DISC	AN
SAE 10	53,98
SAE 11,5	39,68
SAE 14	25,40



PO Box 17 • Barnack Road • Stamford • Lincolnshire • PE9 2NB

Tel: 00 44 (0)1780 484000 • Fax: 00 44 (0)1780 484100

Website: www.newage-avkseg.com